

The LED flood lighting can focus and spot the lighting to a far distance and light big area, not just indoor but also outdoor, built-in driver, compact size, easy to install, widely used in warehouse factory & commercial & Industrial area

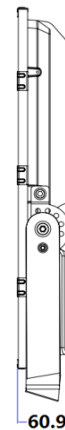

TECHNICAL CHARACTERISTICS

Input Voltage	: 230V/AC 50HZ
Rating Power	: 200W
Electronic Driver	: Integrated High Performance Isolated Driver
Power Factor (PF)	: >0.9
Body Color	: Black
Beam Angle	: 120°
Color Temperature	: 5000-6500K White color
Working Temperature	: +60°C
PROTECTION	High voltage cut-off to protect circuitry
	Short & Over loading protect circuitry
	IP66 for waterproof
CONSTRUCTION	Aluminum body
	Tempered Glass
	Metal hanger
DIMENSION	: 330mm(W)X370mm(H)X60.9mm(D)
PACKING	: One unit Per carton
APPLICATION	: Indoor / Outdoor
COMPLIANCE	: SAA
WARRANTY	: 3 YEARS



DIMENSION (mm)

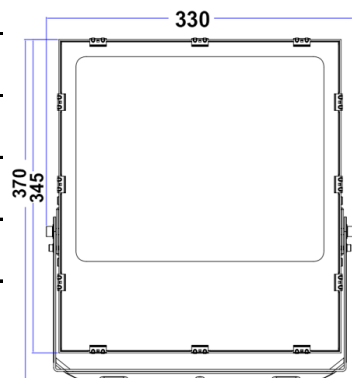

ORDERING INFORMATION

MODEL	LIFE SPAN	WEIGHT GROSS
ST-TG20092B	50,000 HOURS	2.30Kg